

# PREISLISTE

---



Eiswürfelbereiter  
Flockeneisbereiter  
Nuggeteisbereiter

04 **Serie EW / EW Series**

---

08 **Serie HK / HK Series**

---

14 **Serie VW / VW Series**

---

18 **Serie FE / FE Series**

---

22 **Serie NE / NE Series**

---

24 **Vorratsbehälter / Storage bins**

---

28 **Abdeckungen und Zubehör / Covers and accessories**

---

# GELO LINE EW21 - EW24

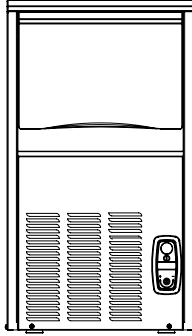

## EW21 A - EW21 W

**UVP 799,00 €**

Art-Nr.: GLEW21A  
EAN-Nr.: 4260496529997  
Art-Nr.: GLEW21W  
EAN-Nr.: 4260548410006

### EIGENSCHAFTEN / FEATURES

Abmessungen (BxTxH) / Dimension (WPH)	340 x 480 x 600 mm
Produktion kg/24h (10°/10°) / Production kg/24h (10°/10°)	(A) 21 / (W) 21 kg
Kapazität Vorratsbehälter / Bin capacity	6,5 kg
Netto Gewicht / Net weight	28 kg
Anschluss / Voltage	220-240V/1/50Hz

### VERPACKUNGSDATEN / SHIPPING DATA

Verpackung / Carton 400 x 530 x 760 mm - 33 kg ca.

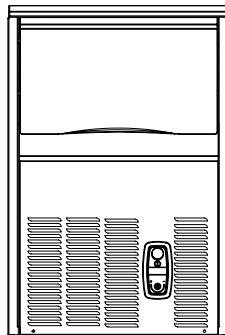

## EW24 A - EW24 W

**UVP 1.049,00 €**

Art-Nr.: GLEW24A  
EAN-Nr.: 4260548410013  
Art-Nr.: GLEW24W  
EAN-Nr.: 4260548410020

### EIGENSCHAFTEN / FEATURES

Abmessungen (BxTxH) / Dimension (WPH)	400 x 480 x 600 mm
Produktion kg/24h (10°/10°) / Production kg/24h (10°/10°)	(A) 24 / (W) 22,5 kg
Kapazität Vorratsbehälter / Bin capacity	7 kg
Netto Gewicht / Net weight	34 kg
Anschluss / Voltage	220-240V/1/50Hz

### VERPACKUNGSDATEN / SHIPPING DATA

Verpackung / Carton 460 x 540 x 760 mm - 42 kg ca.

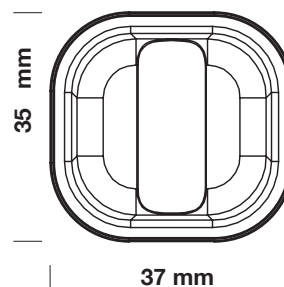
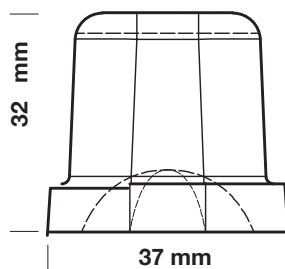

**20 g**

Eiswürfel Gewicht

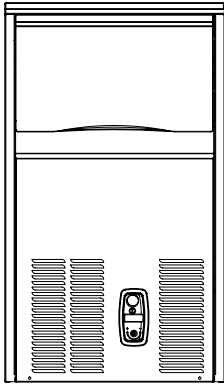

## EW36 A - EW36 W

**UVP 1.099,00 €**

Art-Nr.: GLEW36A  
EAN-Nr.: 4260548410068  
Art-Nr.: GLEW36W  
EAN-Nr.: 4260548410075

### EIGENSCHAFTEN / FEATURES

Abmessungen (BxTxH) / Dimension (WPH)	400 x 540 x 690 mm
Produktion kg/24h (10°/10°) / Production kg/24h (10°/10°)	(A) 36 / (W) 36 kg
Kapazität Vorratsbehälter / Bin capacity	11,5 kg
Netto Gewicht / Net weight	36 kg
Anschluss / Voltage	220-240V/1/50Hz

### VERPACKUNGSDATEN / SHIPPING DATA

Verpackung / Carton	460 x 600 x 850 mm - 44 kg ca.
---------------------	--------------------------------

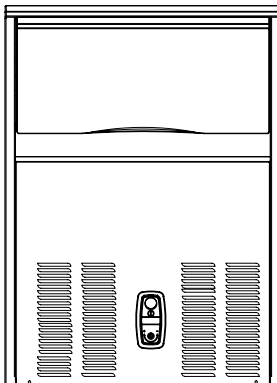

## EW41 A - EW41 W

**UVP 1.299,00 €**

Art-Nr.: GLEW41A  
EAN-Nr.: 4260548410082  
Art-Nr.: GLEW41W  
EAN-Nr.: 4260548410099

### EIGENSCHAFTEN / FEATURES

Abmessungen (BxTxH) / Dimension (WPH)	500 x 540 x 690 mm
Produktion kg/24h (10°/10°) / Production kg/24h (10°/10°)	(A) 41 / (W) 40 kg
Kapazität Vorratsbehälter / Bin capacity	15 kg
Netto Gewicht / Net weight	39 kg
Anschluss / Voltage	220-240V/1/50Hz

### VERPACKUNGSDATEN / SHIPPING DATA

Verpackung / Carton	560 x 600 x 850 mm - 48 kg ca.
---------------------	--------------------------------

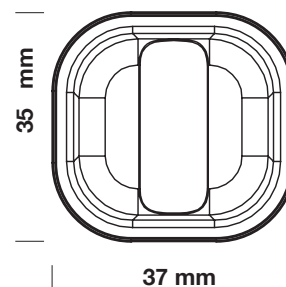
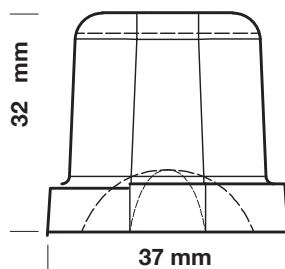

**20 g**

Eiswürfel Gewicht

# GELO LINE EW52 - EW72

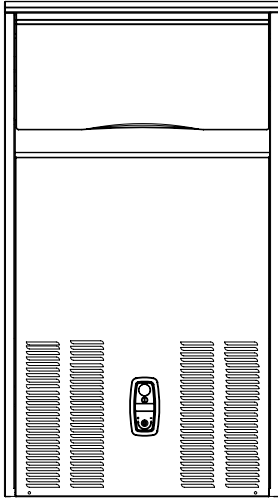

## EW52 A - EW52 W

**UVP 1.399,00 €**

Art-Nr.: GLEW52A  
EAN-Nr.: 4260548410105

### EIGENSCHAFTEN / FEATURES

Art-Nr.: GLEW52W  
EAN-Nr.: 4260548410112

Abmessungen (BxTxH) / Dimension (WPH)	500 X 580 X 800 mm
Produktion kg/24h (10°/10°) / Production kg/24h (10°/10°)	(A) 52 / (W) 54 kg
Kapazität Vorratsbehälter / Bin capacity	18 kg
Netto Gewicht / Net weight	48 kg
Anschluss / Voltage	220-240V/1/50Hz

### VERPACKUNGSDATEN / SHIPPING DATA

Verpackung / Carton	560 x 640 x 960 mm - 56 kg ca.
---------------------	--------------------------------

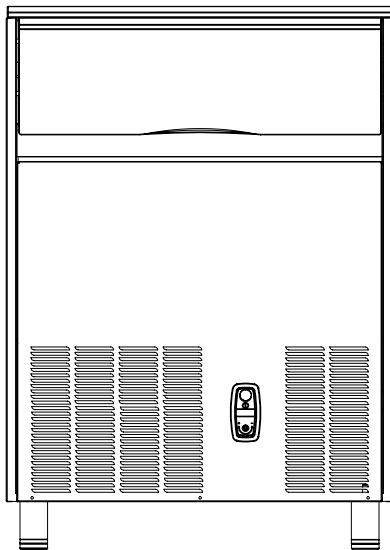

## EW72 A - EW72 W

**UVP 1.699,00 €**

Art-Nr.: GLEW72A  
EAN-Nr.: 4260548410129

### EIGENSCHAFTEN / FEATURES

Art-Nr.: GLEW72W  
EAN-Nr.: 4260548410136

Abmessungen (BxTxH) / Dimension (WPH)	700 X 580 X 995 mm
Produktion kg/24h (10°/10°) / Production kg/24h (10°/10°)	(A) 72 / (W) 70 kg
Kapazität Vorratsbehälter / Bin capacity	42 kg
Netto Gewicht / Net weight	57 kg
Anschluss / Voltage	220-240V/1/50Hz

### VERPACKUNGSDATEN / SHIPPING DATA

Verpackung / Carton	760 x 630 x 1070 mm - 69 kg
---------------------	-----------------------------

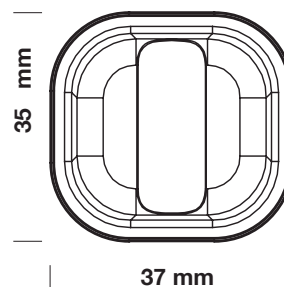
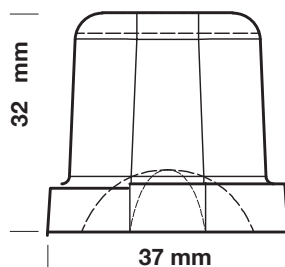

**20 g**

Eiswürfel Gewicht

# GELO LINE EW89

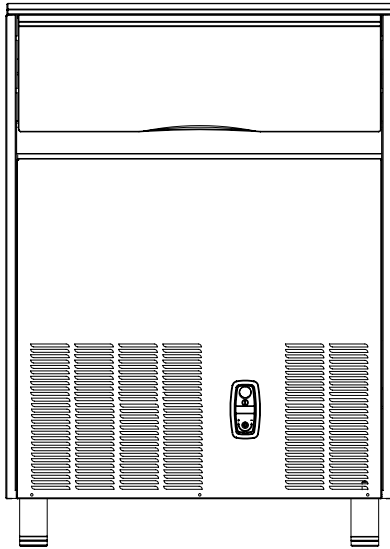

## EW89 A - EW89 W

UVP 1.899,00 €

Art-Nr.: GLEW89A  
EAN-Nr.: 4260548410143

Art-Nr.: GLEW89W  
EAN-Nr.: 4260548410150

### EIGENSCHAFTEN / FEATURES

Abmessungen (BxTxH) / Dimension (WPH)	700 X 580 X 995 mm
Produktion kg/24h (10°/10°) / Production kg/24h (10°/10°)	(A) 89 / (W) 89 kg
Kapazität Vorratsbehälter / Bin capacity	42 kg
Netto Gewicht / Net weight	61 kg
Anschluss / Voltage	220-240V/1/50Hz

### VERPACKUNGSDATEN / SHIPPING DATA

Verpackung / Carton	760 x 630 x 1070 mm - 73 kg
---------------------	-----------------------------

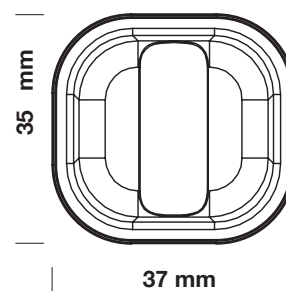
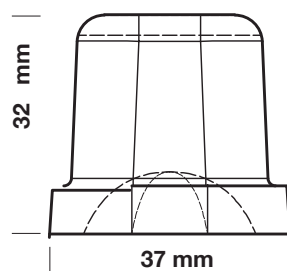

**20 g**

Eiswürfel Gewicht

# GELO LINE HK21

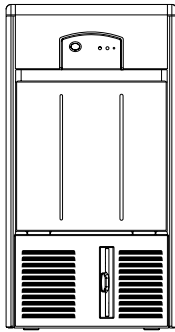

## HK21 nano A - HK21 nano W UVP 1.099,00 €

Art-Nr.: GLHK21nanoA  
EAN-Nr.: 4260548410174

### EIGENSCHAFTEN / FEATURES

Art-Nr.: GLHK21nanoW  
EAN-Nr.: 4260548410198

Abmessungen (BxTxH) / Dimension (WPH)	340 x 545 x 620 mm
Produktion kg/24h (10°/10°) / Production kg/24h (10°/10°)	(A) 21 kg - (W) 19 kg
Kapazität Vorratsbehälter / Bin capacity	5 kg
Netto Gewicht / Net weight	(A) 30 kg - (W) 30 kg
Anschluss / Voltage	220-240V/1/50Hz
Volumen / Volume	0,19

### VERPACKUNGSDATEN / SHIPPING DATA

Verpackung / Carton 400 x 600 x 780 mm - 35 kg ca.

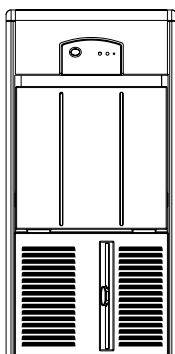

## HK21 A - HK21 W UVP 1.099,00 €

Art-Nr.: GLHK21A  
EAN-Nr.: 4260548410167

### EIGENSCHAFTEN / FEATURES

Art-Nr.: GLHK21W  
EAN-Nr.: 4260548410181

Abmessungen (BxTxH) / Dimension (WPH)	340 x 545 x 690 mm
Produktion kg/24h (10°/10°) / Production kg/24h (10°/10°)	(A) 21 kg - (W) 19 kg
Kapazität Vorratsbehälter / Bin capacity	7 kg
Netto Gewicht / Net weight	(A) 30 kg - (W) 29 kg
Anschluss / Voltage	220-240V/1/50Hz
Volumen / Volume	0,21

### VERPACKUNGSDATEN / SHIPPING DATA

Verpackung / Carton 400 x 600 x 850 mm - 35 kg ca.

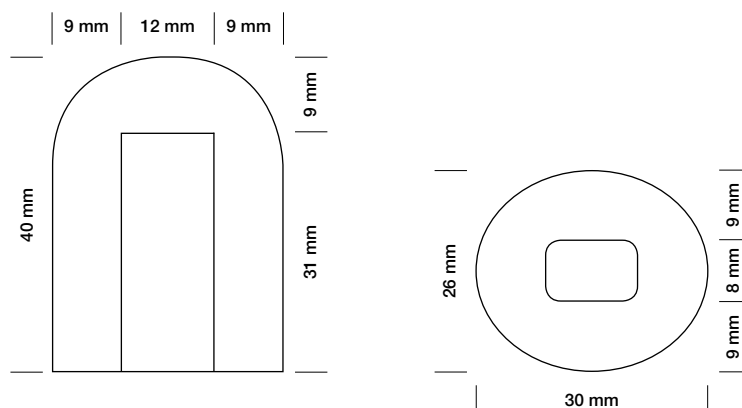

**17 g**

Eiswürfel Gewicht

# HK25 - HK30

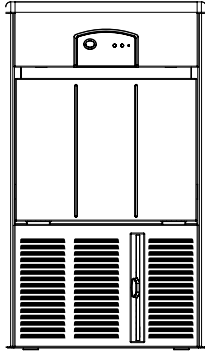

## HK25 A - HK25 W

**UVP 1.149,00 €**

Art-Nr.: GLHK25A  
EAN-Nr.: 4260548410204

### EIGENSCHAFTEN / FEATURES

Art-Nr.: GLHK25W  
EAN-Nr.: 4260548410211

Abmessungen (BxTxH) / Dimension (WPH)	400 x 545 x 690 mm
Produktion kg/24h (10°/10°) / Production kg/24h (10°/10°)	(A) 25 kg - (W) 23 kg
Kapazität Vorratsbehälter / Bin capacity	10 kg
Netto Gewicht / Net weight	(A) 33 kg - (W) 32 kg
Anschluss / Voltage	220-240V/1/50Hz
Volumen / Volume	0,24

### VERPACKUNGSDATEN / SHIPPING DATA

Verpackung / Carton 460 x 600 x 850 mm - 39 kg ca.

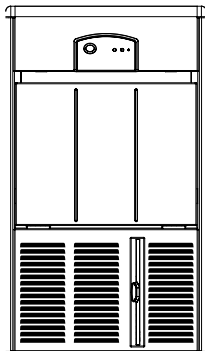

## HK30 A - HK30 W

**UVP 1.299,00 €**

Art-Nr.: GLHK30A  
EAN-Nr.: 4260548410228

### EIGENSCHAFTEN / FEATURES

Art-Nr.: GLHK30W  
EAN-Nr.: 4260548410235

Abmessungen (BxTxH) / Dimension (WPH)	400 x 545 x 690 mm
Produktion kg/24h (10°/10°) / Production kg/24h (10°/10°)	(A) 30 kg - (W) 27 kg
Kapazität Vorratsbehälter / Bin capacity	10 kg
Netto Gewicht / Net weight	(A) 33 kg - (W) 32 kg
Anschluss / Voltage	220-240V/1/50Hz
Volumen / Volume	0,24

### VERPACKUNGSDATEN / SHIPPING DATA

Verpackung / Carton 460 x 600 x 850 mm - 39 kg ca.

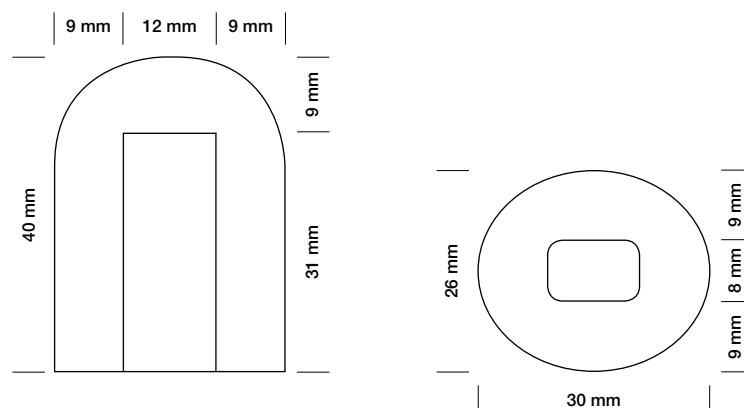

**17 g**

Eiswürfel Gewicht



# GELO LINE HK37 - HK45

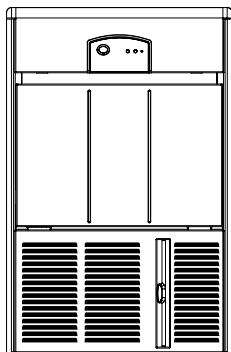

## HK37 A - HK37 W

UVP 1.499,00 €

Art-Nr.: GLHK37A  
EAN-Nr.: 4260548410242

### EIGENSCHAFTEN / FEATURES

Art-Nr.: GLHK37W  
EAN-Nr.: 4260548410259

Abmessungen (BxTxH) / Dimension (WPH)	450 x 545 x 690 mm
Produktion kg/24h (10°/10°) / Production kg/24h (10°/10°)	(A) 37 kg - (W) 35 kg
Kapazität Vorratsbehälter / Bin capacity	12 kg
Netto Gewicht / Net weight	(A) 36 kg - (W) 37 kg
Anschluss / Voltage	220-240V/1/50Hz
Volumen / Volume	0,26

### VERPACKUNGSDATEN / SHIPPING DATA

Verpackung / Carton	510 x 600 x 850 mm - 43 kg ca.
---------------------	--------------------------------

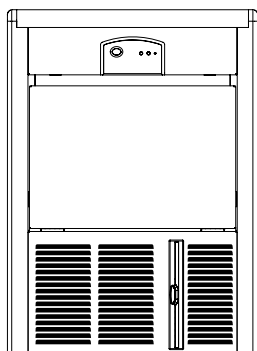

## HK45 A - HK45 W

1.799,00 €

Art-Nr.: GLHK45A  
EAN-Nr.: 4260548410266

### EIGENSCHAFTEN / FEATURES

Art-Nr.: GLHK45W  
EAN-Nr.: 4260548410273

Abmessungen (BxTxH) / Dimension (WPH)	500 x 600 x 693 mm
Produktion kg/24h (10°/10°) / Production kg/24h (10°/10°)	(A) 45 kg - (W) 46 kg
Kapazität Vorratsbehälter / Bin capacity	16 kg
Netto Gewicht / Net weight	(A) 41 kg - (W) 41 kg
Anschluss / Voltage	220-240V/1/50Hz
Volumen / Volume	0,32

### VERPACKUNGSDATEN / SHIPPING DATA

Verpackung / Carton	560 x 660 x 850 mm - 48 kg ca.
---------------------	--------------------------------

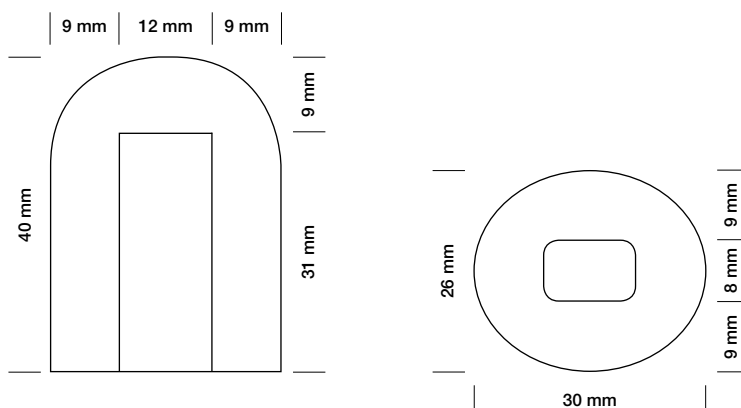

17 g

Eiswürfel Gewicht

# GELO LINE HK50 - HK60

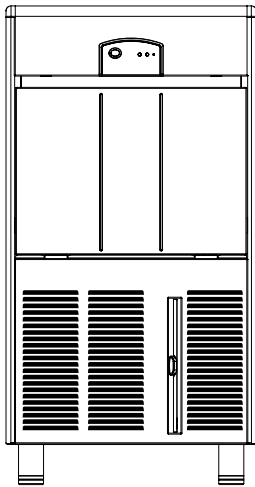

## HK50 A - HK50 W

**UVP 1.899,00 €**

Art-Nr.: GLHK50A  
EAN-Nr.: 4260548410280

### CARATTERISTICHE / FEATURES

Art-Nr.: GLHK50W  
EAN-Nr.: 4260548410297

Abmessungen (BxTxH) / Dimension (WPH)	500 x 585 x 956 mm
Produktion kg/24h (10°/10°) / Production kg/24h (10°/10°)	(A) 50 kg - (W) 48 kg
Kapazität Vorratsbehälter / Bin capacity	21 kg
Netto Gewicht / Net weight	(A) 51 kg - (W) 50 kg
Anschluss / Voltage	220-240V/1/50Hz
Volumen / Volume	0,38

### VERPACKUNGSDATEN / SHIPPING DATA

Verpackung / Carton 560 x 640 x 1050 mm - 58 kg ca.

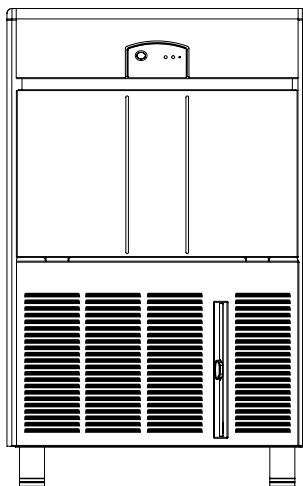

## HK60 A - HK60 W

**1.999,00 €**

Art-Nr.: GLHK60A  
EAN-Nr.: 4260548410303

### CARATTERISTICHE / FEATURES

Art-Nr.: GLHK60W  
EAN-Nr.: 4260548410310

Abmessungen (BxTxH) / Dimension (WPH)	600 x 585 x 956 mm
Produktion kg/24h (10°/10°) / Production kg/24h (10°/10°)	(A) 60 kg - (W) 58 kg
Kapazität Vorratsbehälter / Bin capacity	28 kg
Netto Gewicht / Net weight	(A) 52 kg - (W) 50 kg
Anschluss / Voltage	220-240V/1/50Hz
Volumen / Volume	0,45

### VERPACKUNGSDATEN / SHIPPING DATA

Verpackung / Carton 660 x 640 x 1050 mm - 60 kg ca.

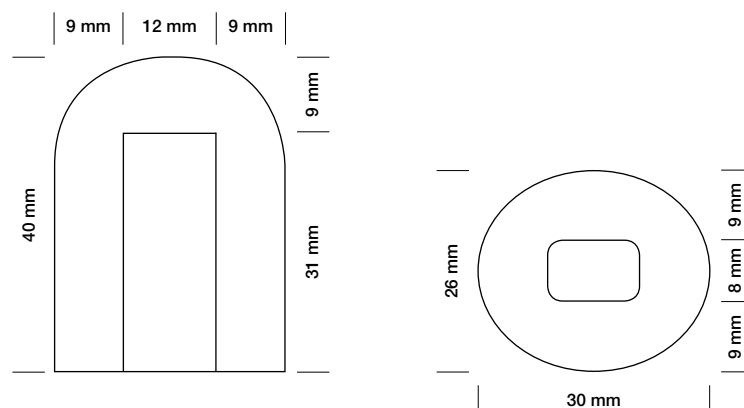

**17 g**

Eiswürfel Gewicht

# GELO LINE HK75 - HK85

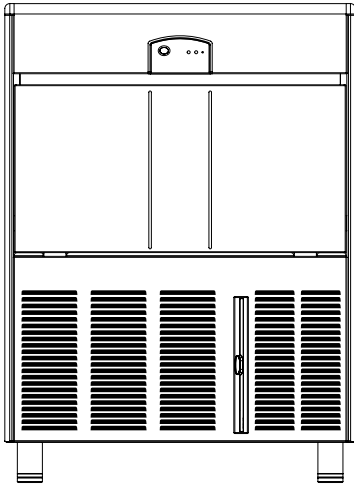

## HK75 A - HK75 W

UVP 2.399,00 €

Art-Nr.: GLHK75A  
EAN-Nr.: 4260548410327

### EIGENSCHAFTEN / FEATURES

Art-Nr.: GLHK75W  
EAN-Nr.: 4260548410334

Abmessungen (BxTxH) / Dimension (WPH)	700 x 585 x 956 mm
Produktion kg/24h (10°/10°) / Production kg/24h (10°/10°)	(A) 75 kg - (W) 72 kg
Kapazität Vorratsbehälter / Bin capacity	36 kg
Netto Gewicht / Net weight	(A) 55 kg - (W) 54 kg
Anschluss / Voltage	220-240V/1/50Hz
Volumen / Volume	0,52

### VERPACKUNGSDATEN / SHIPPING DATA

Verpackung / Carton 760 x 640 x 1050 mm - 63 kg ca.

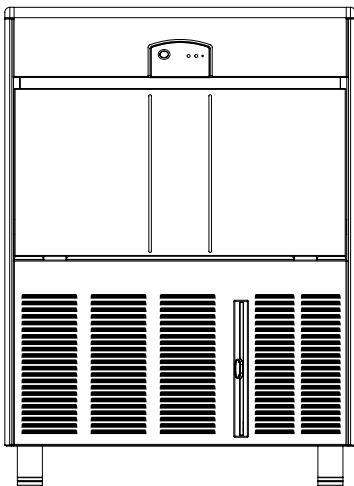

## HK85 A - HK85 W

UVP 2.599,00 €

Art-Nr.: GLHK85A  
EAN-Nr.: 4260548410341

### EIGENSCHAFTEN / FEATURES

Art-Nr.: GLHK85W  
EAN-Nr.: 4260548410358

Abmessungen (BxTxH) / Dimension (WPH)	700 x 585 x 956 mm
Produktion kg/24h (10°/10°) / Production kg/24h (10°/10°)	(A) 85 kg - (W) 81 kg
Kapazität Vorratsbehälter / Bin capacity	36 kg
Netto Gewicht / Net weight	(A) 55 kg - (W) 54 kg
Anschluss / Voltage	220-240V/1/50Hz
Volumen / Volume	0,52

### VERPACKUNGSDATEN / SHIPPING DATA

Verpackung / Carton 760 x 640 x 1050 mm - 63 kg ca.

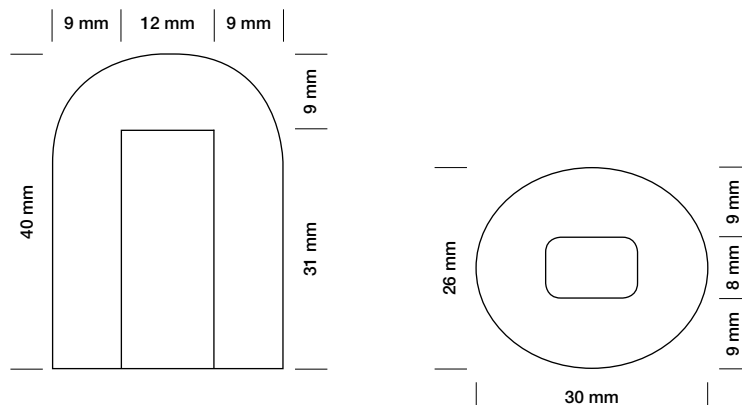

17 g

Gewicht Eiswürfel

# HK92 - HK150

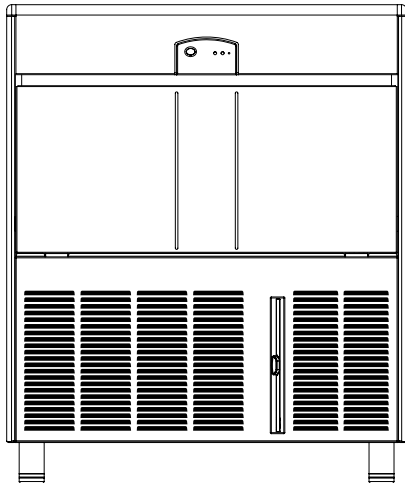

## HK92 A - HK92 W

**UVP 2.799,00 €**

Art-Nr.: GLHK92A  
EAN-Nr.: 4260548410365

Art-Nr.: GLHK92W  
EAN-Nr.: 4260548410372

### EIGENSCHAFTEN / FEATURES

Abmessungen (BxTxH) / Dimension (WPH)	800 x 585 x 956 mm
Produktion kg/24h (10°/10°) / Production kg/24h (10°/10°)	(A) 92 kg - (W) 90 kg
Kapazität Vorratsbehälter / Bin capacity	40 kg
Netto Gewicht / Net weight	(A) 68 kg - (W) 68 kg
Anschluss / Voltage	220-240V/1/50Hz
Volumen / Volume	0,58

### VERPACKUNGSDATEN / SHIPPING DATA

Verpackung / Carton	860 x 640 x 1050 mm - 76 kg ca.
---------------------	---------------------------------

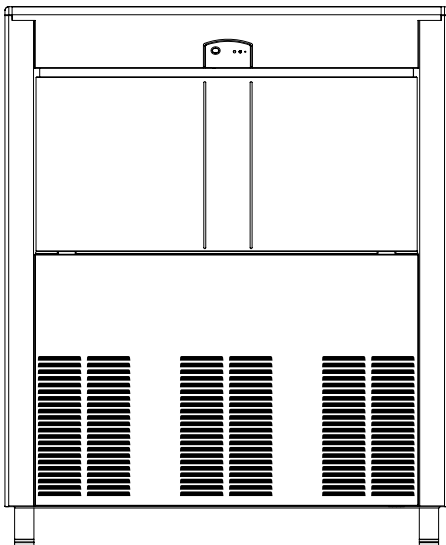

## HK150 A - HK150 W

**UVP 3.499,00 €**

Art-Nr.: GLHK150A  
EAN-Nr.: 4260548410389

Art-Nr.: GLHK150W  
EAN-Nr.: 4260548410396

### EIGENSCHAFTEN / FEATURES

Abmessungen (BxTxH) / Dimension (WPH)	920 x 650 x 1279 mm
Produktion kg/24h (10°/10°) / Production kg/24h (10°/10°)	(A) 150 kg - (W) 142 kg
Kapazität Vorratsbehälter / Bin capacity	67 kg
Netto Gewicht / Net weight	(A) 100 kg - (W) 100 kg
Anschluss / Voltage	220-240V/1/50Hz
Volumen / Volume	0,93

### VERPACKUNGSDATEN / SHIPPING DATA

Verpackung / Carton	975 x 1370 x 1450 mm - 116 kg ca.
---------------------	-----------------------------------

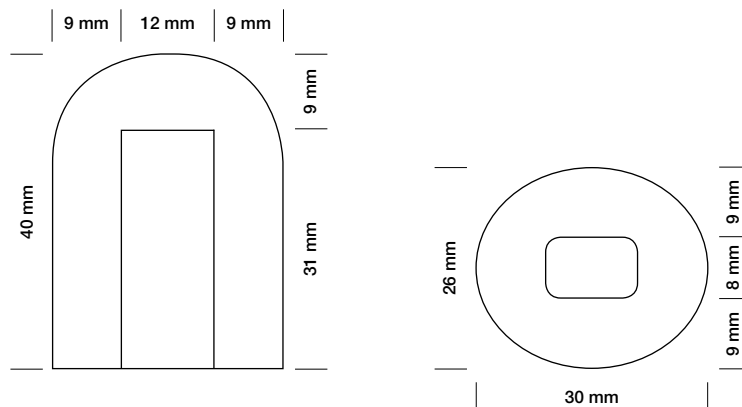

**17 g**

Gewicht Eiswürfel

# VW154 - VW225

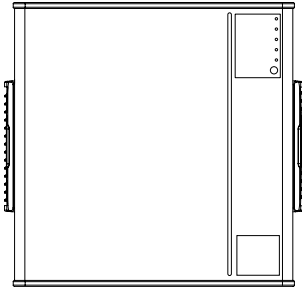

## VW154 A VW154 W

**UVP 2.599,00 €**

Art-Nr.: GLVW 154A  
EAN-Nr.: 4260548410402

Art-Nr.: GLVW 154W  
EAN-Nr.: 4260548410419

### EIGENSCHAFTEN / FEATURES

Abmessungen (BxTxH) / Dimension (WPH)	560 x 620 x 575 mm
Produktion kg/24h (10°/10°) / Production kg/24h (10°/10°)	(A) 154 kg - (W) 136 kg
Empfohlene Vorratsbehälter / Suggested Storage Bin	D105 - D155
Netto Gewicht / Net weight	(A) 53 kg - (W) 53 kg
Anschluss / Voltage	220-240V/1/50Hz
Volumen / Volume	0,33

### VERPACKUNGSDATEN / SHIPPING DATA

Verpackung / Carton 630 x 690 x 740 mm - 65 kg ca.

Wenn nicht explizit deklariert, wird die "WÜRFEL" - Konfiguration (s. Datenblatt) bereitgestellt

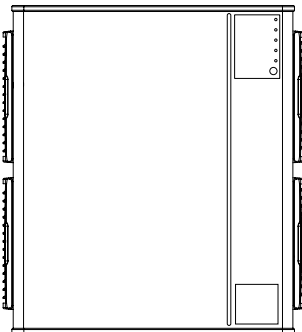

## VW225 A VW225 W

**UVP 2.949,00 €**

Art-Nr.: GLVW 225A  
EAN-Nr.: 4260548410426

Art-Nr.: GLVW 225W  
EAN-Nr.: 4260548410433

### EIGENSCHAFTEN / FEATURES

Abmessungen (BxTxH) / Dimension (WPH)	560 x 620 x 660 mm
Produktion kg/24h (10°/10°) / Production kg/24h (10°/10°)	(A) 225 kg - (W) 205 kg
Empfohlene Vorratsbehälter / Suggested Storage Bin	D105 - D155
Netto Gewicht / Net weight	(A) 68 kg - (W) 68 kg
Anschluss / Voltage	220-240V/1/50Hz
Volumen / Volume	0,36

### VERPACKUNGSDATEN / SHIPPING DATA

Verpackung / Carton 630 x 690 x 810 mm - 80 kg ca.

Wenn nicht explizit deklariert, wird die "WÜRFEL" - Konfiguration bereitgestellt

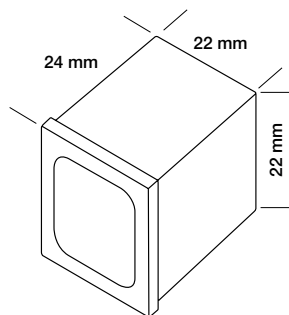

WÜRFEL

**10 g**

Gewicht Eiswürfel

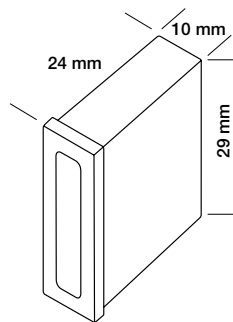

HALBER WÜRFEL

**6 g**

Gewicht Eiswürfel

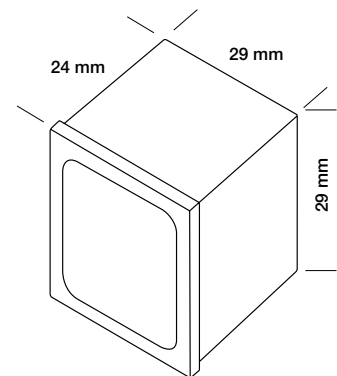

GROSSER WÜRFEL

**17 g**

Gewicht Eiswürfel



# VW240 - VW320

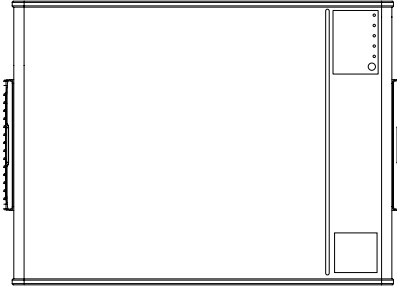

## VW240 A VW240 W

**UVP 2.899,00 €**

Art-Nr.: GLVW240A  
EAN-Nr.: 4260548410440

Art-Nr.: GLVW240W  
EAN-Nr.: 4260548410457

### EIGENSCHAFTEN / FEATURES

Abmessungen (BxTxH) / Dimension (WPH)	760 x 620 x 575 mm
Produktion kg/24h (10°/10°) / Production kg/24h (10°/10°)	(A) 240 kg - (W) 220 kg
Empfohlene Vorratsbehälter / Suggested Storgae Bin	D205 - D255 - D305
Netto Gewicht / Net weight	(A) 70 kg - (W) 70 kg
Anschluss / Voltage	220-240V/1/50Hz
Volumen / Volume	0,43

### VERPACKUNGSDATEN / SHIPPING DATA

Verpackung / Carton 830 x 690 x 740 mm - 85 kg ca.

Wenn nicht explizit deklariert, wird die "WÜRFEL" - Konfiguration bereitgestellt

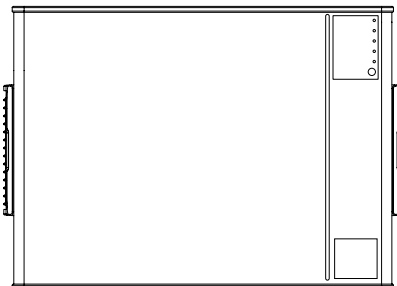

## VW320 A VW320 W

**UVP 3.399,00 €**

Art-Nr.: GLVW320A  
EAN-Nr.: 4260548410464

Art-Nr.: GLVW320W  
EAN-Nr.: 4260548410471

### EIGENSCHAFTEN / FEATURES

Abmessungen (BxTxH) / Dimension (WPH)	760 x 620 x 575 mm
Produktion kg/24h (10°/10°) / Production kg/24h (10°/10°)	(A) 320 kg - (W) 285 kg
Empfohlene Vorratsbehälter / Suggested Storgae Bin	D205 - D255 - D305
Netto Gewicht / Net weight	(A) 71 kg - (W) 71 kg
Anschluss / Voltage	220-240V/1/50Hz
Volumen / Volume	0,43

### VERPACKUNGSDATEN / SHIPPING DATA

Verpackung / Carton 830 x 690 x 740 mm - 86 kg ca.

Wenn nicht explizit deklariert, wird die "WÜRFEL" - Konfiguration bereitgestellt

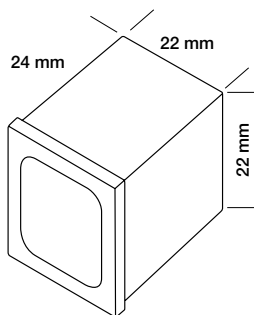

WÜRFEL

**10 g**

Gewicht Eiswürfel

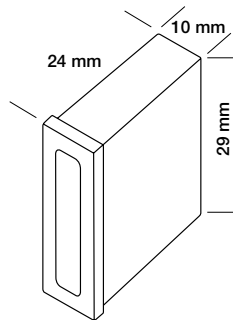

HALBER WÜRFEL

**6 g**

Gewicht Eiswürfel

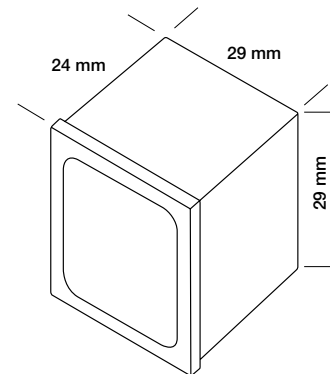

GROSSER WÜRFEL

**17 g**

Gewicht Eiswürfel

# VW430 - VW465

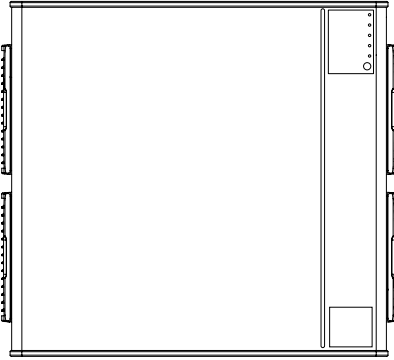

## VW430 A VW430 W

**UVP 4.199,00 €**

Art-Nr.: GLVW430A  
EAN-Nr.: 4260548410488

Art-Nr.: GLVW430W  
EAN-Nr.: 4260548410495

### EIGENSCHAFTEN / FEATURES

Abmessungen (BxTxH) / Dimension (WPH)	760 x 620 x 725 mm
Produktion kg/24h (10°/10°) / Production kg/24h (10°/10°)	(A) 430 kg - (W) 370 kg
Empfohlene Vorratsbehälter / Suggested Storage Bin	D205 - D255 - D305
Netto Gewicht / Net weight	(A) 88 kg - (W) 83 kg
Anschluss / Voltage	220-240V/1/50Hz
Volumen / Volume	0,52

### VERPACKUNGSDATEN / SHIPPING DATA

Verpackung / Carton 830 x 690 x 900 mm - 106 kg ca.

Wenn nicht explizit deklariert, wird die "WÜRFEL" - Konfiguration bereitgestellt

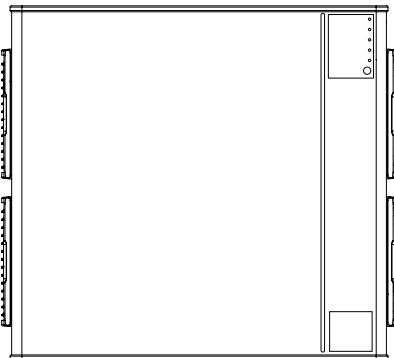

## VW465 A VW465 W

**UVP 5.099,00 €**

Art-Nr.: GLVW465A  
EAN-Nr.: 4260548410501

Art-Nr.: GLVW465W  
EAN-Nr.: 4260548410518

### EIGENSCHAFTEN / FEATURES

Abmessungen (BxTxH) / Dimension (WPH)	760 x 620 x 725 mm
Produktion kg/24h (10°/10°) / Production kg/24h (10°/10°)	(A) 465 kg - (W) 410 kg
Empfohlene Vorratsbehälter / Suggested Storage Bin	D205 - D255 - D305
Netto Gewicht / Net weight	(A) 98 kg - (W) 98 kg
Anschluss / Voltage	400V/3N/50Hz
Volumen / Volume	0,52

### VERPACKUNGSDATEN / SHIPPING DATA

Verpackung / Carton 830 x 690 x 900 mm - 116 kg ca.

Wenn nicht explizit deklariert, wird die "WÜRFEL" - Konfiguration bereitgestellt

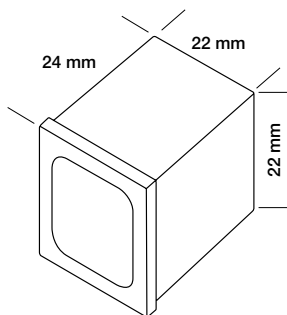

WÜRFEL

**10 g**

Gewicht Eiswürfel

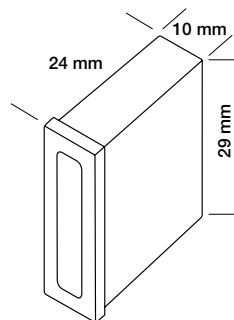

HALBER WÜRFEL

**6 g**

Gewicht Eiswürfel

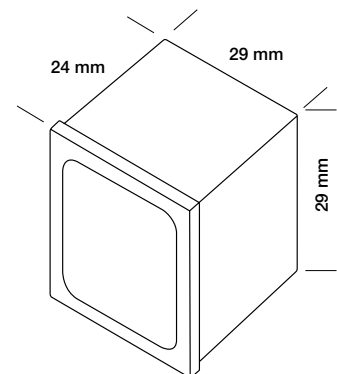

GROSSER WÜRFEL

**17 g**

Gewicht Eiswürfel

# VW210 ECO - VW220 ECO

## R290

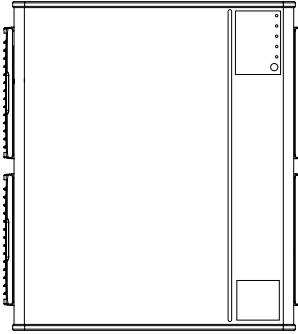

### VW210 ECO A VW210 ECO W

**UVP 3.149,00 €**

Art-Nr.: GLVW210ECOA  
EAN-Nr.: 4260548410525

#### EIGENSCHAFTEN / FEATURES

Abmessungen (BxTxH) / Dimension (WPH)	560 x 620 x 660 mm
Produktion kg/24h (10°/10°) / Production kg/24h (10°/10°)	210 kg
Empfohlene Vorratsbehälter / Suggested Storage Bin	D105 - D155
Netto Gewicht / Net weight	68 kg
Anschluss / Voltage	220-240V/1/50Hz
Volumen / Volume	0,36

#### VERPACKUNGSDATEN / SHIPPING DATA

Verpackung / Carton 630 x 690 x 810 mm - 78 kg ca.

Wenn nicht explizit deklariert, wird die "WÜRFEL" - Konfiguration bereitgestellt

### VW220 ECO A - VW220 ECO W

**UVP 3.199,00 €**

Art-Nr.: GLVW220ECOA  
EAN-Nr.: 4260548410549

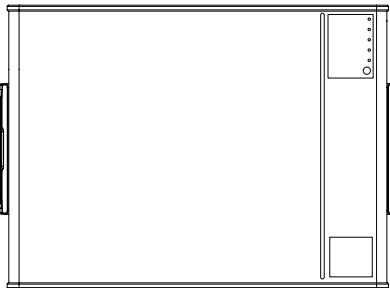

#### EIGENSCHAFTEN / FEATURES

Abmessungen (BxTxH) / Dimension (WPH)	760 x 620 x 575 mm
Produktion kg/24h (10°/10°) / Production kg/24h (10°/10°)	220 kg
Empfohlene Vorratsbehälter / Suggested Storage Bin	D205 - D255 - D305
Netto Gewicht / Net weight	70 kg
Anschluss / Voltage	220-240V/1/50Hz
Volumen / Volume	0,43

#### VERPACKUNGSDATEN / SHIPPING DATA

Verpackung / Carton 830 x 690 x 740 mm - 80 kg ca.

Wenn nicht explizit deklariert, wird die "WÜRFEL" - Konfiguration bereitgestellt

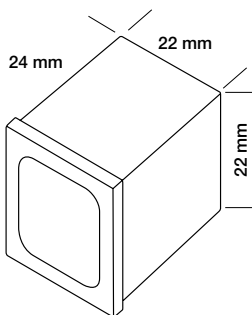

WÜRFEL

**10 g**

Gewicht Eiswürfel

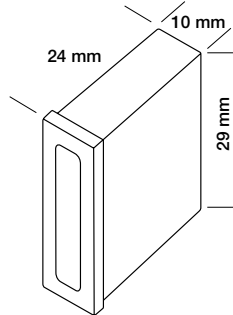

HALBER WÜRFEL

**6 g**

Gewicht Eiswürfel

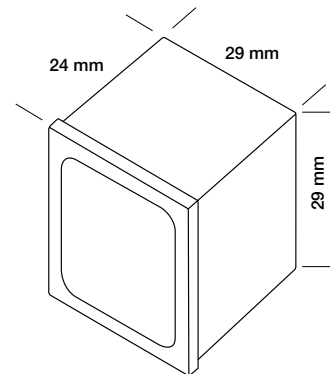

GROSSER WÜRFEL

**17 g**

Gewicht Eiswürfel





# FE90 C - FE120 C

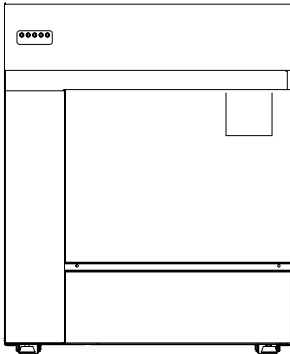

## FE90 C A FE90 C W

**UVP 2.999,00 €**

Art-Nr.: GLFE90CA  
EAN-Nr.: 4260548410563

Art-Nr.: GLFE90CW  
EAN-Nr.: 4260548410570

### EIGENSCHAFTEN / FEATURES

Abmessungen (BxTxH) / Dimension (WPH)	570 x 600 x 695 mm
Produktion kg/24h (10°/10°) / Production kg/24h (10°/10°)	(A) 90 kg - (W) 86 kg
Kapazität Vorratsbehälter / Bin capacity	20 kg
Netto Gewicht / Net weight	(A) 53 kg - (W) 52 kg
Anschluss / Voltage	220-240V/1/50Hz
Volumen / Volume	0,37

### VERPACKUNGSDATEN / SHIPPING DATA

Verpackung / Carton 640 x 660 x 870 mm - 60 kg ca.

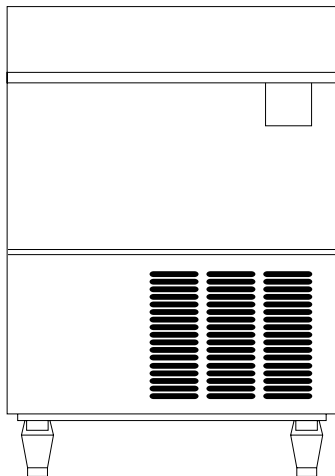

## FE120 C A FE120 C W

**UVP 3.199,00 €**

Art-Nr.: GLFE120CA  
EAN-Nr.: 4260548410587

Art-Nr.: GLFE120CW  
EAN-Nr.: 4260548410594

### EIGENSCHAFTEN / FEATURES

Abmessungen (BxTxH) / Dimension (WPH)	680 x 510 x 1000 mm
Produktion kg/24h (10°/10°) / Production kg/24h (10°/10°)	(A) 120 kg - (W) 120 kg
Kapazität Vorratsbehälter / Bin capacity	27 kg
Netto Gewicht / Net weight	(A) 64 kg - (W) 64 kg
Anschluss / Voltage	220-240V/1/50Hz
Volumen / Volume	0,48

### VERPACKUNGSDATEN / SHIPPING DATA

Verpackung / Carton 750 x 580 x 1090 mm - 74 kg ca.

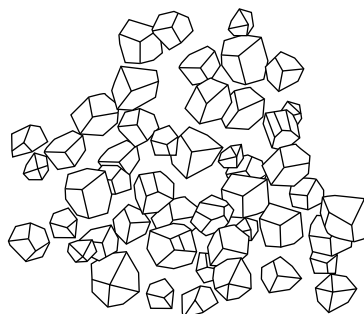

**25 %**

Eis enthält Restwasser



# FE120 - FE200

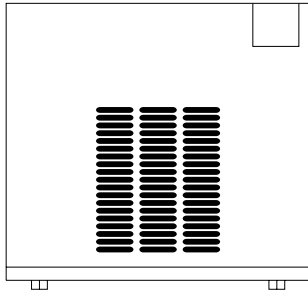

## FE120 A FE120 W

**UVP 2.899,00 €**

Art-Nr.: GLFE120A  
EAN-Nr.: 4260548410600

Art-Nr.: GLFE120W  
EAN-Nr.: 4260548410617

### EIGENSCHAFTEN / FEATURES

Abmessungen (BxTxH) / Dimension (WPH)	564 x 536 x 531 mm
Produktion kg/24h (10°/10°) / Production kg/24h (10°/10°)	(A) 120 kg - (W) 120 kg
Empfohlene Vorratsbehälter / Suggest Storage Bin	D105 - D155
Netto Gewicht / Net weight	(A) 45 kg - (W) 45 kg
Anschluss / Voltage	220-240V/1/50Hz
Volumen / Volume	0,25

### VERPACKUNGSDATEN / SHIPPING DATA

Verpackung / Carton 630 x 610 x 690 mm - 52 kg ca.

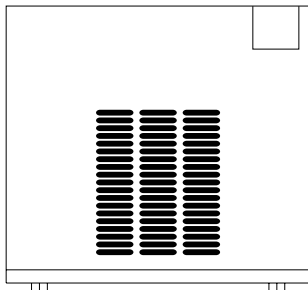

## FE200 A FE200 W

**UVP 3.299,00 €**

Art-Nr.: GLFE200A  
EAN-Nr.: 4260548410624

Art-Nr.: GLFE200W  
EAN-Nr.: 4260548410631

### EIGENSCHAFTEN / FEATURES

Abmessungen (BxTxH) / Dimension (WPH)	564 x 536 x 531 mm
Produktion kg/24h (10°/10°) / Production kg/24h (10°/10°)	(A) 200 kg - (W) 200 kg
Empfohlene Vorratsbehälter / Suggest Storage Bin	D105 - D155
Netto Gewicht / Net weight	(A) 49 kg - (W) 49 kg
Anschluss / Voltage	220-240V/1/50Hz
Volumen / Volume	0,25

### VERPACKUNGSDATEN / SHIPPING DATA

Verpackung / Carton 650 x 610 x 690 mm - 56 kg ca.

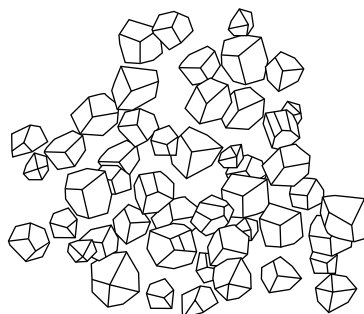

**25 %**

Eis enthält Restwasser



# FE320 - FE600

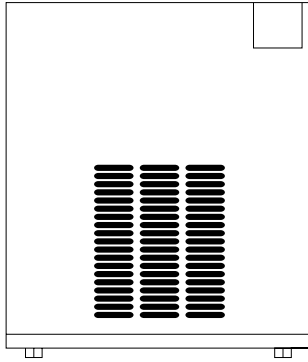

## FE320 A FE320 W

**UVP 4.899,00 €**

Art-Nr.: GLFE320A  
EAN-Nr.: 4260548410648

Art-Nr.: GLFE320W  
EAN-Nr.: 4260548410655

### EIGENSCHAFTEN / FEATURES

Abmessungen (BxTxH) / Dimension (WPH)	538 x 663 x 650 mm
Produktion kg/24h (10°/10°) / Production kg/24h (10°/10°)	(A) 320 kg - (W) 330 kg
Empfohlene Vorratsbehälter / Suggest Storage Bin	D205 - D305 - DR140 - DR320
Netto Gewicht / Net weight	(A) 78 kg - (W) 78 kg
Anschluss / Voltage	220-240V/1/50Hz
Volumen / Volume	0,36

### VERPACKUNGSDATEN / SHIPPING DATA

Verpackung / Carton	600 x 750 x 800 mm - 87 kg ca.
---------------------	--------------------------------

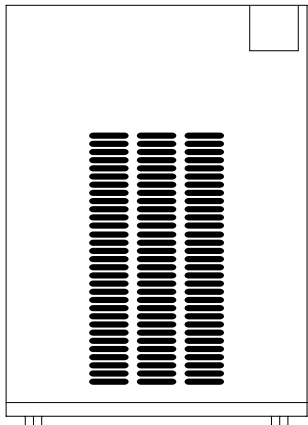

## F600 A F600 W

**UVP 5.999,00 €**

Art-Nr.: GLFE600A  
EAN-Nr.: 4260548410662

Art-Nr.: GLFE600W  
EAN-Nr.: 4260548410679

### EIGENSCHAFTEN / FEATURES

Abmessungen (BxTxH) / Dimension (WPH)	538 x 663 x 790 mm
Produktion kg/24h (10°/10°) / Production kg/24h (10°/10°)	(A) 600 kg - (W) 600 kg
Empfohlene Vorratsbehälter / Suggest Storage Bin	D405 - UD500 - UD700 DR140 - DR320
Netto Gewicht / Net weight	(A) 95 kg - (W) 95 kg
Anschluss / Voltage	220-240V/1/50Hz
Volumen / Volume	0,44

### VERPACKUNGSDATEN / SHIPPING DATA

Verpackung / Carton	600 x 750 x 930 mm - 104 kg ca.
---------------------	---------------------------------

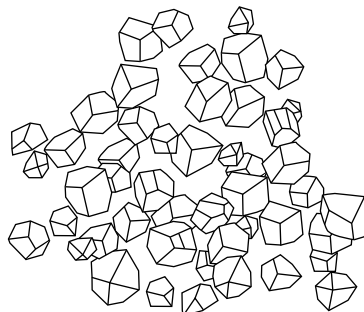

**15-18 %**

Eis enthält Restwasser



# FE1150 - FE2500

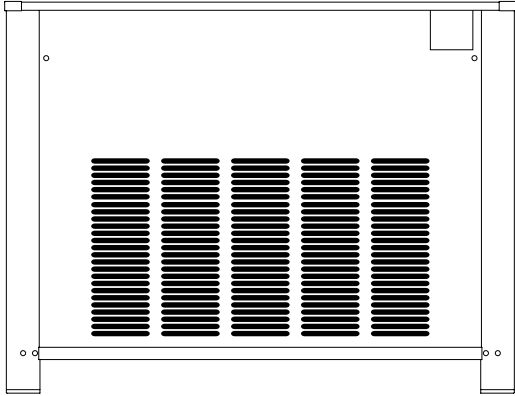

## FE1150 A FE1150 W

**UVP 12.999,00 €**

Art-Nr.: GLSFEN1150A  
EAN-Nr.: 4260548410686

Art-Nr.: GLSFEN1150W  
EAN-Nr.: 4260548410693

### EIGENSCHAFTEN / FEATURES

Abmessungen (BxTxH) / Dimension (WPH)	1065 x 698 x 850 mm
Produktion kg/24h (10°/10°) / Production kg/24h (10°/10°)	(A) 1150 kg - (W) 1220 kg
Empfohlene Vorratsbehälter / Suggest Storage Bin	UD500 - UD700 - UD1000 - DR 620 DR140 - DR320
Netto Gewicht / Net weight	(A) 179 kg - (W) 179 kg
Anschluss / Voltage	380-415V/3/50Hz
Volumen / Volume	1,19

### VERPACKUNGSDATEN / SHIPPING DATA

Verpackung / Carton	1160 x 770 x 1030 mm - 198 kg ca.
---------------------	-----------------------------------

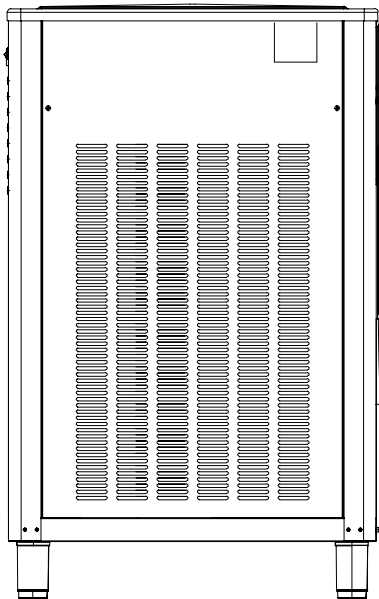

## FE2500 A FE2500 W

**UVP 24.999,00 €**

Art-Nr.: GLSFEN2500A  
EAN-Nr.: 4260548410709

Art-Nr.: GLSFEN2500W  
EAN-Nr.: 4260548410716

### EIGENSCHAFTEN / FEATURES

Abmessungen (BxTxH) / Dimension (WPH)	1080 x 780 x 1255 mm
Produktion kg/24h (10°/10°) / Production kg/24h (10°/10°)	(A) 2500 kg - (W) 2500 kg
Empfohlene Vorratsbehälter / Suggest Storage Bin	UD1000 - DR620
Netto Gewicht / Net weight	(A) 390 kg - (W) 371 kg
Anschluss / Voltage	380-415V/3/50Hz
Volumen / Volume	1,19

### VERPACKUNGSDATEN / SHIPPING DATA

Verpackung / Carton	1170 x 920 x 1340 mm - 411 kg ca.
---------------------	-----------------------------------

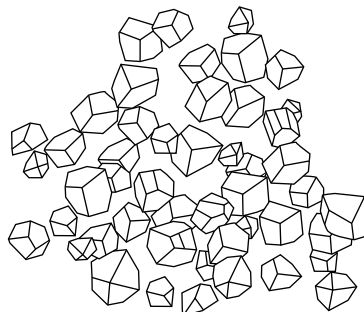

**15-18 %**

Eis enthält Restwasser

# GELO LINE NE270

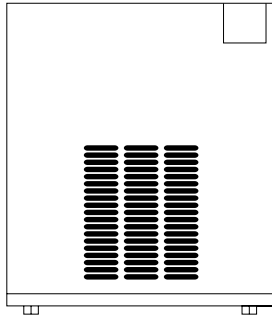

## NE270 A

UVP 4.999,00 €

### EIGENSCHAFTEN / FEATURES

Art-Nr.: GLNE270A  
EAN-Nr.: 4260548410723

Abmessungen (BxTxH) / Dimension (WPH)	538 x 663 x 650 mm
Produktion kg/24h (10°/10°) / Production kg/24h (10°/10°)	(A) 270 kg
Empfohlene Vorratsbehälter / Suggest Storage Bin	D105 - D155
Netto Gewicht / Net weight	(A) 78 kg - (W) 78 kg
Anschluss / Voltage	220-240V/1/50Hz
Volumen / Volume	0,37

### VERPACKUNGSDATEN / SHIPPING DATA

Verpackung / Carton	750 x 600 x 800 mm - 87 kg ca.
---------------------	--------------------------------

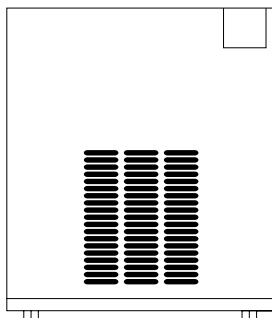

## NE270 S A

UVP 4.999,00 €

### EIGENSCHAFTEN / FEATURES

Art-Nr.: GLNE270SA  
EAN-Nr.: 4260548410747

Abmessungen (BxTxH) / Dimension (WPH)	538 x 663 x 650 mm
Produktion kg/24h (10°/10°) / Production kg/24h (10°/10°)	(A) 270 kg
Empfohlene Vorratsbehälter / Suggest Storage Bin	D105 - D155
Netto Gewicht / Net weight	(A) 78 kg - (W) 78 kg
Anschluss / Voltage	220-240V/1/50Hz
Volumen / Volume	0,37

### VERPACKUNGSDATEN / SHIPPING DATA

Verpackung / Carton	750 x 600 x 800 mm - 87 kg ca.
---------------------	--------------------------------

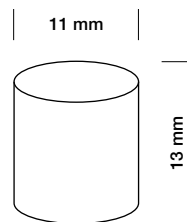

S = SMALL

1 g

Eisnugget Gewicht

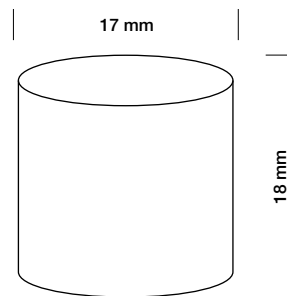

5

Eisnugget Gewicht

8 %

Eis enthält Restwasser

# GELO LINE NE470

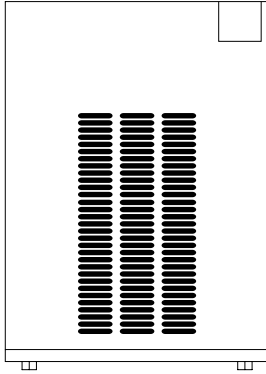

## NE470 A

UVP 6.099,00 €

### EIGENSCHAFTEN / FEATURES

Art-Nr.: GLNE470A  
EAN-Nr.: 4260548410761

Abmessungen (BxTxH) / Dimension (WPH)	538 x 663 x 790 mm
Produktion kg/24h (10°/10°) / Production kg/24h (10°/10°)	(A) 470 kg
Empfohlene Vorratsbehälter / Suggest Storage Bin	D255 - D405
Netto Gewicht / Net weight	(A) 94 kg - (W) 94 kg
Anschluss / Voltage	220-240V/1/50Hz
Volumen / Volume	0,43

### VERPACKUNGSDATEN / SHIPPING DATA

610 x 760 x 930 mm - 103 kg ca.

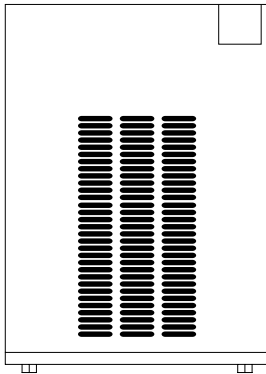

## NE470 S A

UVP 6.099,00 €

### EIGENSCHAFTEN / FEATURES

Art-Nr.: GLNE470SA  
EAN-Nr.: 4260548410785

Abmessungen (BxTxH) / Dimension (WPH)	538 x 663 x 790 mm
Produktion kg/24h (10°/10°) / Production kg/24h (10°/10°)	(A) 470 kg
Empfohlene Vorratsbehälter / Suggest Storage Bin	D255 - D405
Netto Gewicht / Net weight	(A) 94 kg - (W) 94 kg
Anschluss / Voltage	220-240V/1/50Hz
Volumen / Volume	0,43

### VERPACKUNGSDATEN / SHIPPING DATA

Verpackung / Carton

610 x 760 x 930 mm - 103 kg ca.

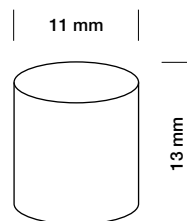

S = SMALL

**1 g**

Eisnugget Gewicht

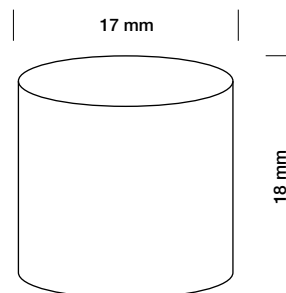

**5**

Eisnugget Gewicht

**8 %**

Eis enthält Restwasser

# GELO LINE D105 - D155

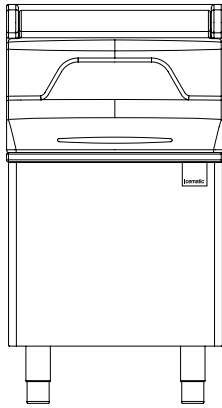

## D105

UVP 999,00 €

Art-Nr.: GLD105

EAN-Nr.: 4260548410839

### EIGENSCHAFTEN / FEATURES

Abmessungen (BxTxH) / Dimension (WPH)	568 x 848 x 1048 mm
Kapazität Vorratsbehälter / Bin capacity	129 kg
Netto Gewicht / Net weight	36 kg
Ausführung / Construction	Edelstahl / Inox steel

### KOMPATIBILITÄT / COMPATIBILITY

VW154

VW225

VW210 ECO

FE120

FE200

### VERPACKUNGSDATEN / SHIPPING DATA

Verpackung / Carton	620 x 885 x 1050 mm - 50 kg ca.
---------------------	---------------------------------

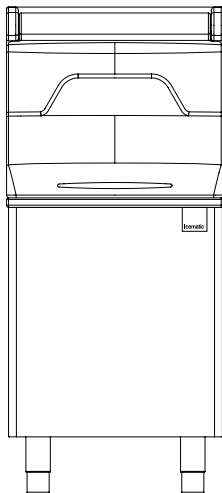

## D155

UVP 1.199,00 €

Art-Nr.: GLD155

EAN-Nr.: 4260548410846

### EIGENSCHAFTEN / FEATURES

Abmessungen (BxTxH) / Dimension (WPH)	568 x 880 x 1270 mm
Kapazität Vorratsbehälter / Bin capacity	168 kg
Netto Gewicht / Net weight	48 kg
Ausführung / Construction	Edelstahl / Inox steel

### KOMPATIBILITÄT / COMPATIBILITY

VW154

VW225

VW210 ECO

FE120

FE200

### VERPACKUNGSDATEN / SHIPPING DATA

Verpackung / Carton	620 x 940 x 1310 mm - 62 kg ca.
---------------------	---------------------------------

# GELO LINE D205 - D255

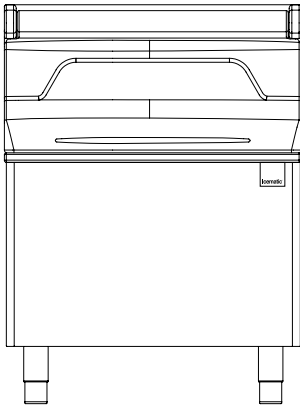

## D205

UVP 1.299,00 €

### EIGENSCHAFTEN / FEATURES

Art-Nr.: GLD205  
EAN-Nr.: 4260548410853

Abmessungen (BxTxH) / Dimension (WPH)	768 x 848 x 1048 mm
Kapazität Vorratsbehälter / Bin capacity	181 kg
Netto Gewicht / Net weight	43 kg
Ausführung / Construction	Edelstahl/ Inox steel

### KOMPATIBILITÄT / COMPATIBILITY

VW154 + KM205-255

VW225 + KM205-255

VW320

VW210 ECO

VW430

VW465

FE120 + KF205-255

FE200 + KF205-255

FE320 + KF205-255

FE600 + KF205-255

NE270 + KF205-255

NE470 + KF205-255

### VERPACKUNGSDATEN / SHIPPING DATA

Verpackung / Carton 822 x 885 x 1050 mm - 56 kg ca.

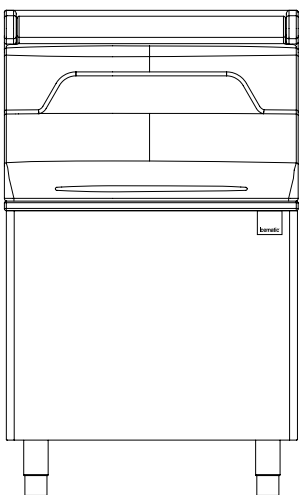

## D255

UVP 1.499,00 €

### EIGENSCHAFTEN / FEATURES

Art-Nr.: GLD255  
EAN-Nr.: 4260548410860

Abmessungen (BxTxH) / Dimension (WPH)	770 x 880 x 1270 mm
Kapazität Vorratsbehälter / Bin capacity	243 kg
Netto Gewicht / Net weight	55 kg
Ausführung / Construction	Edelstahl/ Inox steel

### KOMPATIBILITÄT / COMPATIBILITY

VW154 + KM205-255

VW225 + KM205-255

VW240

VW205 ECO

VW320

VW430

VW465

FE120 + KF205-255

FE200 + KF205-255

FE320 + KF205-255

FE600 + KF205-255

NE270 + KF205-255

NE470 + KF205-255

### VERPACKUNGSDATEN / SHIPPING DATA

Verpackung / Carton 830 x 950 x 1310 mm - 70 kg ca.



# GELO LINE D305 - D405

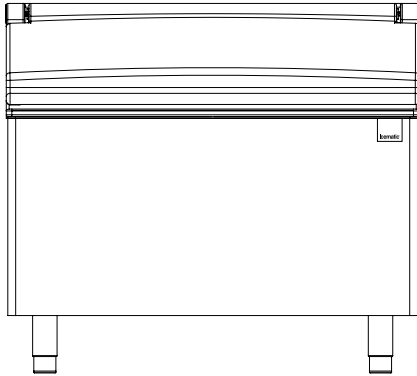

## D305

UVP 1.699,00 €

Art-Nr.: GLD305

EAN-Nr.: 4260548410877

### EIGENSCHAFTEN / FEATURES

Abmessungen (BxTxH) / Dimension (WPH)	1081 x 824 x 968 mm
Kapazität Vorratsbehälter / Bin capacity	252 kg
Netto Gewicht / Net weight	48 kg
Ausführung / Construction	Edelstahl / Inox steel

### KOMPATIBILITÄT / COMPATIBILITY

VW240 + KM305

VW220 ECO + KM305

VW320 + KM305

VW430 + KM305

VW465 + KM305

FE120 + KF305

FE200 + KF305

SFE330 + KF305

SFE600 + KF305

NE270 + KF305

NE470 + KF305

### VERPACKUNGSDATEN / SHIPPING DATA

Verpackung / Carton 1140 x 910 x 960 mm - 63 kg ca.

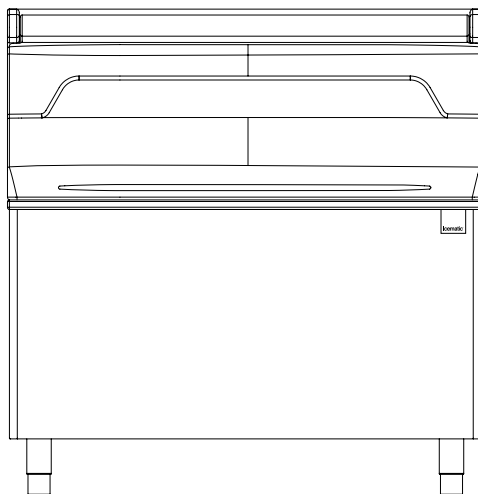

## D405

UVP 1.899,00 €

Art-Nr.: GLD405

EAN-Nr.: 4260548410884

### EIGENSCHAFTEN / FEATURES

Abmessungen (BxTxH) / Dimension (WPH)	1235 x 873 x 1270 mm
Kapazität Vorratsbehälter / Bin capacity	406 kg
Netto Gewicht / Net weight	73 kg
Ausführung / Construction	Edelstahl / Inox steel

### KOMPATIBILITÄT / COMPATIBILITY

VW240 + KFM405

VW320 + KFM405

VW430 + KFM405

VW465 + KFM405

SFE330 + KFM405

SFE600 + KFM405

NE270 + KFM405

NE470 + KFM405

### VERPACKUNGSDATEN / SHIPPING DATA

Verpackung / Carton 1300 x 940 x 1310 mm - 97 kg ca.

# GELO LINE D505

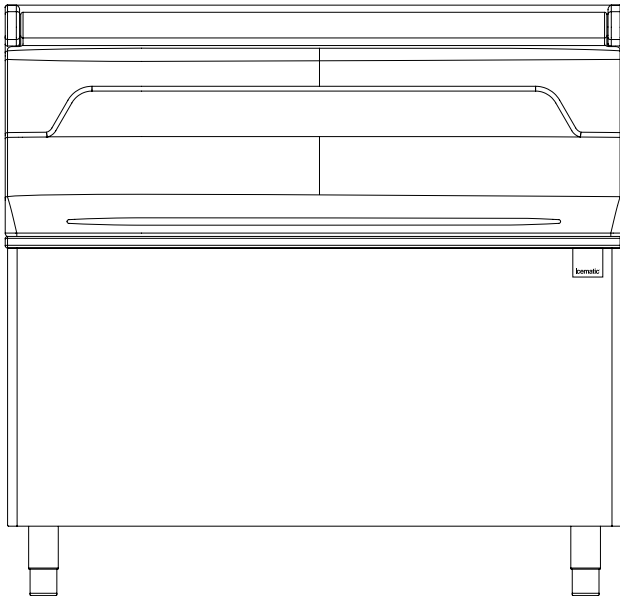

## D505

UVP 2.199,00 €

### EIGENSCHAFTEN / FEATURES

Art-Nr.: GLD505

EAN-Nr.: 4260548410891

Abmessungen (BxTxH) / Dimension (WPH)	1331 x 880 x 1270 mm
Kapazität Vorratsbehälter / Bin capacity	478 kg
Netto Gewicht / Net weight	77 kg
Ausführung / Construction	Edelstahl / Inox steel

### KOMPATIBILITÄT / COMPATIBILITY

VW240 + KFM505

VW220 ECO + KFM505

VW320 + KFM505

VW430 + KFM505

VW465 + KFM505

FE120 + KFM505

FE200 + KFM505

SFE330 + KFM505

SFE600 + KFM505

NE270 + KFM505

NE470 + KFM505

### VERPACKUNGSDATEN / SHIPPING DATA

Verpackung / Carton	1395 x 940 x 1310 mm - 100 kg ca.
---------------------	-----------------------------------



# Abdeckungen und Zubehör Covers and accessories

KM205-255	Edelstahl Abdeckung für D205 und D255 mit Maschinen der VW Serie / Stainless steel cover for bins D205 and D255 with machines VW series	UVP 460,00 Art-Nr.: GLKM205-255 EAN-Nr.: 4260548410976
KF205-255	Edelstahl Abdeckung für D205 und D255 mit Maschinen der FE Serie / Stainless steel cover for bins D205 and D255 with machines FE series	UVP 500,00 Art-Nr.: GLKF205-255 EAN-Nr.: 4260548410983
KM305	Edelstahl Abdeckung für D305 mit Maschinen der VW Serie / Stainless steel cover for bin D305 with machines VW series	UVP 480,00 Art-Nr.: GLKM305 EAN-Nr.: 4260548410990
KF305	Edelstahl Abdeckung für D305 mit Maschinen der FE Serie/ Stainless steel cover for bin D305 with machines FE series	UVP 410,00 Art-Nr.: GLKF305 EAN-Nr.: 4260548411003
KFM405	Edelstahl Abdeckung für D405 mit Maschinen der FE und VW Serien / Stainless steel cover for bin D405 with machines FE series and VW	UVP 430,00 Art-Nr.: GLKFM405 EAN-Nr.: 4260548411010
KFM505	Edelstahl Abdeckung für D505 mit Maschinen der FE und VW Serie/ Stainless steel cover for bin D505 with machines FE series and VW	UVP 440,00 Art-Nr.: GLKFM505 EAN-Nr.: 4260548411010
KC300-500	Kit für Seiteneisenauslass SFE330 und SFE500 / Side ice outlet kit for SFE330 and SFE600	UVP 150,00 Art-Nr.: GLKC300-500 EAN-Nr.: 4260548411034
KC1000	Kit für Eisauslass an der Rückseite SFN1220 / Rear ice outlet kit for SFN1220	UVP 320,00 Art-Nr.: GLKC1000 EAN-Nr.: 4260548411041
Reinigungs-Kit/ Cleaning kit	Reinigungs-Kit für Serie HK / Cleaning and sanitising kit for HK series	UVP 50,00 Art-Nr.: GLClear EAN-Nr.: 4260548411058
Kit Füße/ Feets kit	Kit Füße für HK21 - HK25 - HK35 - HK45 - EW20 - EW25 - EW30 - EW40 - EW50 Feets kit suitable for HK21 - HK25 - HK35 - HK45 - EW20 - EW25 - EW30 - EW40 - EW50	UVP 90,00 Art-Nr.: GLFeet EAN-Nr.: 4260548411065